

**105M12 and 108M12
Industrial Ethernet Switches
Installation
Guide**

105M12 & 108M12 Industrial Ethernet Switches Installation Guide



Copyright, © N-TRON Corp., 2008
820 S. University Blvd., Suite 4E
Mobile, AL 36609 USA

All rights reserved. Reproduction, adaptation, or translation without prior written permission from N-TRON Corp. is prohibited, except as allowed under copyright laws.

Ethernet is a registered trademark of Xerox Corporation. All other product names, company names, logos or other designations mentioned herein are trademarks of their respective owners.

The information contained in this document is subject to change without notice. N-TRON Corp. makes no warranty of any kind with regard to this material, including, but not limited to, the implied warranties of merchantability or fitness for a particular purpose. In no event shall N-TRON Corp. be liable for any incidental, special, indirect or consequential damages whatsoever included but not limited to lost profits arising out of errors or omissions in this manual or the information contained herein.

SAFETY WARNINGS

ELECTRICAL SAFETY



WARNING: Disconnect the power cable before removing the end plates.

WARNING: Do not operate the unit with the end plates removed.

WARNING: Properly ground the unit before connecting anything else to the unit. Units not properly grounded may result in a safety risk and could be hazardous and may void the warranty. See the grounding technique section of this user manual for proper ways to ground the unit.

WARNING: Do not work on equipment or cables during periods of lightning activity.

WARNING: Do not perform any services on the unit unless qualified to do so.

WARNING: Observe proper DC Voltage polarity when installing power input cables. Reversing voltage polarity can cause permanent damage to the unit and void the warranty.

HAZARDOUS LOCATION INSTALLATION REQUIREMENTS

1. **WARNING:** Explosion hazard. Do not remove or replace the device unless power has been switched off or the area is known to be non-hazardous.
2. **WARNING:** Explosion hazard. Do not disconnect while the circuit is live or unless the area is known to be non-hazardous..
3. **WARNING:** Explosion hazard. Substitution of components may impair suitability for Class I, Division 2.
4. **WARNING:** Install only in accordance with Local & National Codes of Authorities Having Jurisdiction.
5. Class I, Div 2 installations require that all devices connected to this product must be UL listed for the area in which it is installed.
6. Limited Operating Voltage: 12-30V for Class I, Div 2 installations.
7. This equipment is suitable for use in Class I, Div 2, Groups A, B, C, and D, or non-hazardous locations only.

105M12 Industrial Ethernet Switch

The 105M12 is an unmanaged industrial Ethernet switch providing five Fast Ethernet copper ports in an IP65/IP67 rated enclosure for protection against temporary immersion in water. The switch provides Category-5 compliant 10/100BaseTX connections with IP65/67 rated M12 D-code connectors for high performance network design, and hub/repeater upgrades. The switch is capable of auto negotiating 10/100 Mb and half/full duplex communications.

108M12 Industrial Ethernet Switch

The 108M12 is an unmanaged industrial Ethernet switch providing eight Fast Ethernet copper ports in an IP65/IP67 rated enclosure for protection against temporary immersion in water. The switch provides eight Category-5 compliant 10/100BaseTX connections with IP65/67 rated M12 D-code connectors for high performance network design, and hub/repeater upgrades. The switch is capable of auto negotiating 10/100 Mb and half/full duplex communications.

Key Features

- IP65 Rated for protection against low pressure jets of water from any direction
- IP66 Rated for protection against high pressure jets of water from any direction
- IP67 Rated for protection against temporary immersion in water
- Full IEEE 802.3
- Extended Environmental Specifications
- Support for Full/Half Duplex Operation
- Auto MDI/MDIX (crossover) on all ports
- LED Link/Activity Status Indication
- Autonegotiation, Autosensing Speed, Duplex, and Flow Control
- Up to 1.0 Gb/s maximum throughput for the 105M12 and 1.6 Gb/s for the 108M12 model
- Redundant power input
- Bulk head mountable (optional Industry Standard 35mm DIN rail mounting available)

108M12-HV Only



INGRESS PROTECTION IP67

The classification of degrees of protection provided by the enclosures is defined by IEC 60529. Each rating is defined by specific tests.

The IP number is comprised of two numbers, the first referring to the protection against solid objects and the second against fluids. The higher the number, the better the device is protected against contact with moving parts and the harmful entry of various forms of moisture.

1st IP	Protection against ingress of solids	2nd IP	Protection against ingress of liquids
0	No protection	0	No protection
1	Protected against solid objects over 50mm e.g. hands, large tools.	1	Protected against vertically falling drops of water.
2	Protected against solid objects over 12mm e.g. hands, large tools.	2	Protected against direct sprays of water up to 15° from vertical.
3	Protected against solid objects over 2.5mm e.g. wire, small tools.	3	Protected against direct sprays of water up to 60° from vertical.
4	Protected against solid objects over 1.0mm e.g. wires.	4	Protected against water sprayed from any direction. Limited ingress permitted.
5	Limited protection against dust ingress (no harmful deposit)	5	Protected against low pressure water jets from any direction. Limited ingress permitted.
6	Totally protected against dust ingress.	6	Protected against high pressure water jets from any direction. Limited ingress permitted.
		7	Protected against temporary immersion between 15cm to 1m.
		8	Protected against long periods of immersion under pressure.

The 105M12 and 108M12 Industrial Ethernet Switches are fully protected against dust and will remain sealed when immersed in water to a depth of 1 meter for 1 hour when all the ports are properly mated or sealed.



These IP67 caps seal off the unused ports protecting them from dirt, water, oil or any other contaminants which might be present in the close proximity of the switch.

PACKAGE CONTENTS

Please make sure the Ethernet Switch package contains the following items:

1. 105M12 or 108M12 Industrial Ethernet Switch
2. Product CD

UNPACKING

Remove all the equipment from the packaging, and store the packaging in a safe place. File any damage claims with the carrier.

INSTALLATION

Read the following warning before beginning the installation:

WARNING



Never install or work on electrical equipment or cabling during periods of lightning activity.

BULKHEAD MOUNTING

The following are the mechanical dimensions and drill hole placements to consider when mounting the 105M12 and 108M12 Industrial Ethernet Switches:

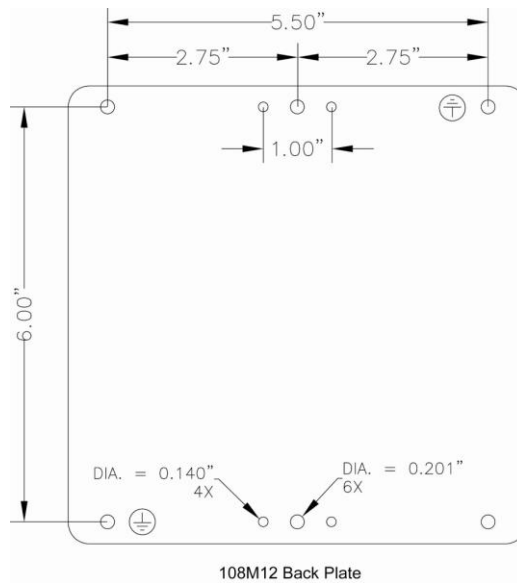
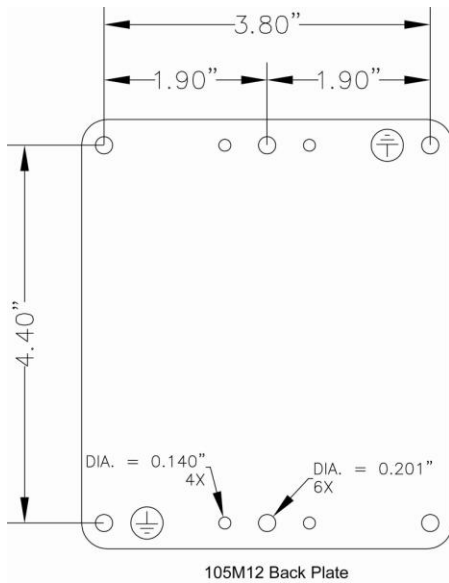

FRONT PANEL

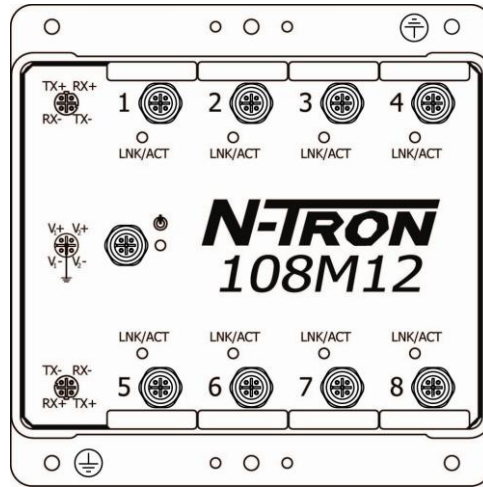
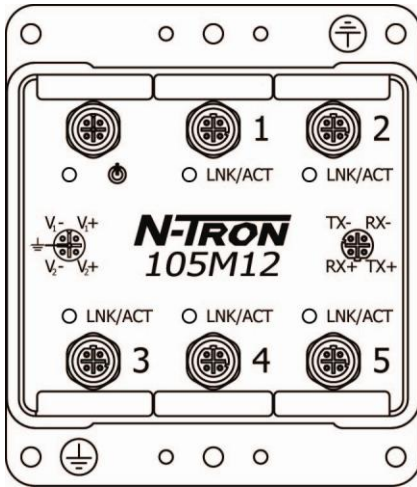

LNK/ACT
M12 D-Coded Female Ports
M12 A-Coded Male Port

Link/Activity LED
 All ports are Auto sensing 10/100BaseTX Connections
 Redundant Power Input (10-30VDC)
 Green LED lights when Power is connected

LED's: The table below describes the operating modes:

LED	Color	Description
	ON	Power is Applied.
	OFF	Power is OFF.
LNK/ACT	ON	Link established, no Activity on cable.
	BLINKING	Link established, Activity on cable
	OFF	No link established

APPLYING POWER

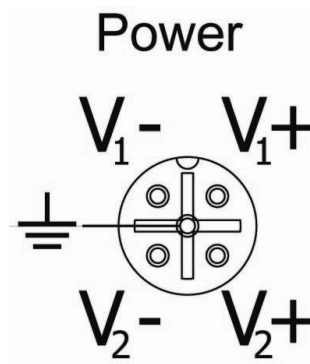

The M12 A coded power connector is keyed, where the mating connection from the power supply can be made only when the male and female ends are lined up properly.

When the power is first connected all LED's will flash ON Momentarily.
Verify the Power LED stays ON (GREEN).

Note: Either V_1 or V_2 can be connected to power for minimal operation. For redundant power operation, V_1 and V_2 must be connected to separate DC Voltage sources. The power cord should be limited to less than 10 meters in order to ensure optimum performance.

Recommended 24V DC Power Supplies, similar to:

100VAC/240VAC:

N-Tron NTPS-24-1.3, DC 24V/1.3A

N-TRON 105M12 AND 108M12 GROUNDING TECHNIQUES

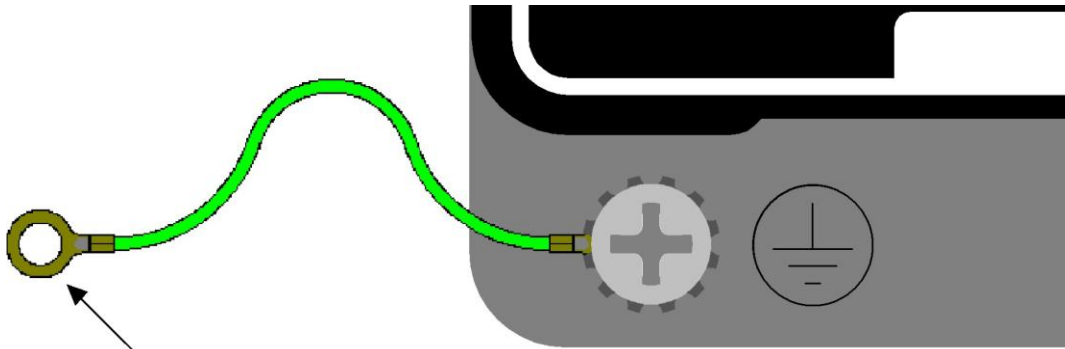

Drain wire with lug connecting switch chassis to known grounding point.

CONNECTING THE UNIT

For 10Base-T ports, plug a Category 3 (or greater) twisted pair cable into the M12 connector. For 100Base-T ports, plug a Category 5 (or greater) twisted pair cable into the M12 connector. Connect the other end to the far end station. Verify that the LNK LED's are ON once the connection has been completed. To connect any other port to another Switch or Repeater, use a standard Cat5 straight through or crossover cable.

Warning: Creating a port to port connection on the same switch (i.e. loop) is an illegal operation and will create a broadcast storm which will crash the network!

TROUBLESHOOTING

1. Make sure the  (Power LED) is ON.
2. Verify that Link LED's are ON or BLINKING for connected ports.
3. Verify cabling used between stations.
4. Verify that cabling is Category 5 (or greater) for 100Mbit Operation.

SUPPORT

Contact N-TRON Corp. at:
TEL: 251-342-2164
FAX: 251-342-6353
www.n-tron.com
N-TRON_Support@n-tron.com

FCC STATEMENT

This product complies with Part 15 of the FCC-A Rules.

Operation is subject to the following conditions:

- (1) This device may not cause harmful interference
- (2) This device must accept any interference received, including interference that may cause undesired operation.

NOTE: This equipment has been tested and found to comply with the limits for a Class A digital device, pursuant to Part 15 of the FCC Rules. These limits are designed to provide reasonable protection against harmful interference in a residential installation. This equipment generates, uses, and can radiate radio frequency energy and, if not installed and used in accordance with the instructions, may cause harmful interference to radio communications. Operation of this device in a residential area is likely to cause harmful interference in which case the user will be required to correct the interference at his own expense.

INDUSTRY CANADA

This Class A digital apparatus meets all requirements of the Canadian Interference Causing Equipment Regulations. Operation is subject to the following two conditions; (1) this device digital apparatus meets all requirements of the Canadian Interference Causing Equipment Regulations. Operation is subject to the following two conditions; (1) this device may not cause harmful interference, and (2) this device must accept any interference received, including interference that may cause undesired operation.

Cet appareillage numérique de la classe A répond à toutes les exigences de l'interférence canadienne causant des règlements d'équipement. L'opération est sujette aux deux conditions suivantes: (1) ce dispositif peut ne pas causer l'interférence nocive, et (2) ce dispositif doit accepter n'importe quelle interférence reçue, y compris l'interférence qui peut causer l'opération peu désirée.

KEY SPECIFICATIONS – 105M12

Physical

<i>Height:</i>	5.00" (12.7cm)
<i>Width:</i>	4.32" (10.97cm)
<i>Depth:</i>	1.8" (4.57cm)
<i>Weight:</i>	1.8 lbs. (0.81kg)
<i>DIN Rail:</i>	35 mm (Optional)

Electrical

<i>Input Voltage:</i>	10-30 VDC (Regulated)
<i>Input Current:</i>	215 mA max. @ 24VDC (Steady State)
<i>Inrush Current:</i>	7.8 Amp/0.7ms max. @ 24VDC
<i>Input Ripple:</i>	Less than 100 mV

Environmental

<i>Operating Temperature:</i>	-40°C to 80°C
<i>Storage Temperature:</i>	-40°C to 85°C
<i>Operating Humidity:</i>	5-100% (Non Condensing)
<i>Operating Altitude:</i>	0 to 10,000 ft.

Network Media

<i>10BaseT:</i>	> Cat-3 Cable
<i>100BaseT:</i>	> Cat-5 Cable

Connectors

<i>10/100BaseTX:</i>	M12, 4 Pin, D-code
<i>Power:</i>	M12, 5 Pin, A-code

Pin Assignments

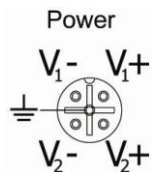
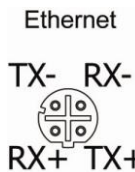

Recommended Wiring Clearance:

Screw On Field Terminated Right
Angle Connector



Front: ~3" (7.62 cm)

Screw On Field Terminated
Straight Version Connector



Front: ~4" (10.16 cm)

KEY SPECIFICATIONS – 108M12

Physical

Height:	6.62" (16.81cm)
Width:	6.62" (16.81cm)
Depth:	1.8" (4.57cm)
Weight:	3.3 lbs. (1.49kg)
DIN Rail	35 mm (Optional)

Electrical

Input Voltage:	10-30 VDC (Regulated)
-HV Option:	10-60 VDC (Regulated)
Input Current:	250 mA max. @ 24VDC (Steady State)
Inrush Current:	8.1 Amp/0.7ms max. @ 24VDC
Input Ripple:	Less than 100 mV

Environmental

Operating Temperature:	-40°C to 70°C
Storage Temperature:	-40°C to 85°C
Operating Humidity:	5-100% (Non Condensing)
Operating Altitude:	0 to 10,000 ft.

Network Media

10BaseT:	> Cat-3 Cable
100BaseT:	> Cat-5 Cable

Connectors

10/100BaseTX:	M12, 4 Pin, D-code
Power:	M12, 5 Pin, A-Code

Pin Assignments

Ethernet

TX- RX-



RX+ TX+

Power

V₁- V₁+



V₂- V₂+

Recommended Wiring Clearance:

Screw On Field Terminated Right Angle Connector



Front: ~3" (7.62 cm)

Screw On Field Terminated Straight Version Connector



Front: ~4" (10.16 cm)

Regulatory Approvals:

Safety: Suitable for use in Class I, Division 2, Groups A, B, C and D Hazardous Locations, or Nonhazardous Locations only.

The high voltage model is TÜV approved GS per EN 60950-1.

EMI: EN61000-6-4, EN55011 - Class A
FCC Title 47, Part 15, Subpart B - Class A
ICES-003 – Class A

EMS: EN61000-6-2
EN61000-4-2 (ESD)
EN61000-4-3 (RS)
EN61000-4-4 (EFT)
EN61000-4-5 (Surge)
EN61000-4-6 (Conducted Disturbances)

GOST-R Certified.

Warranty: Effective January 1, 2008, all N-TRON products carry a 3 year limited warranty from the date of purchase.

N-TRON Limited Warranty

N-TRON, Corp. warrants to the end user that this hardware product will be free from defects in workmanship and materials, under normal use and service, for the applicable warranty period from the date of purchase from N-TRON or its authorized reseller. If a product does not operate as warranted during the applicable warranty period, N-TRON shall, at its option and expense, repair the defective product or part, deliver to customer an equivalent product or part to replace the defective item, or refund to customer the purchase price paid for the defective product. All products that are replaced will become the property of N-TRON. Replacement products may be new or reconditioned. Any replaced or repaired product or part has a ninety (90) day warranty or the remainder of the initial warranty period, whichever is longer.

N-TRON shall not be responsible for any custom software or firmware, configuration information, or memory data of customer contained in, stored on, or integrated with any products returned to N-TRON pursuant to any warranty.

OBTAINING WARRANTY SERVICE: Customer must contact N-TRON within the applicable warranty period to obtain warranty service authorization. Dated proof of purchase from N-TRON or its authorized reseller may be required. Products returned to N-TRON must be pre-authorized by N-TRON with a Return Material Authorization (RMA) number marked on the outside of the package, and sent prepaid and packaged appropriately for safe shipment. Responsibility for loss or damage does not transfer to N-TRON until the returned item is received by N-TRON. The repaired or replaced item will be shipped to the customer, at N-TRON's expense, not later than thirty (30) days after N-TRON receives the product.

N-TRON shall not be responsible for any software, firmware, information, or memory data of customer contained in, stored on, or integrated with any products returned to N-TRON for repair, whether under warranty or not.

ADVANCE REPLACEMENT OPTION: Upon registration, this product qualifies for advance replacement. A replacement product will be shipped within three (3) days after verification by N-TRON that the product is considered defective. The shipment of advance replacement products is subject to local legal requirements and may not be available in all locations. When an advance replacement is provided and customer fails to return the original product to N-TRON within fifteen (15) days after shipment of the replacement, N-TRON will charge customer for the replacement product, at list price.

WARRANTIES EXCLUSIVE: IF AN N-TRON PRODUCT DOES NOT OPERATE AS WARRANTED ABOVE, CUSTOMER'S SOLE REMEDY FOR BREACH OF THAT WARRANTY SHALL BE REPAIR, REPLACEMENT, OR REFUND OF THE PURCHASE PRICE PAID, AT N-TRON'S OPTION. TO THE FULL EXTENT ALLOWED BY LAW, THE FOREGOING WARRANTIES AND REMEDIES ARE EXCLUSIVE AND ARE IN LIEU OF ALL OTHER WARRANTIES, TERMS, OR CONDITIONS, EXPRESS OR IMPLIED, EITHER IN FACT OR BY OPERATION OF LAW, STATUTORY OR OTHERWISE, INCLUDING WARRANTIES, TERMS, OR CONDITIONS OF MERCHANTABILITY, FITNESS FOR A PARTICULAR PURPOSE, SATISFACTORY QUALITY, CORRESPONDENCE WITH DESCRIPTION, AND NON-INFRINGEMENT, ALL OF WHICH ARE EXPRESSLY DISCLAIMED. N-TRON NEITHER ASSUMES NOR AUTHORIZES ANY OTHER PERSON TO ASSUME FOR IT ANY OTHER LIABILITY IN CONNECTION WITH THE SALE, INSTALLATION, MAINTENANCE OR USE OF ITS PRODUCTS. N-TRON SHALL NOT BE LIABLE UNDER THIS WARRANTY IF ITS TESTING AND EXAMINATION DISCLOSE THAT THE ALLEGED DEFECT OR MALFUNCTION IN THE PRODUCT DOES NOT EXIST OR WAS CAUSED BY CUSTOMER'S OR ANY THIRD PERSON'S MISUSE, NEGLIGENCE, IMPROPER INSTALLATION OR TESTING, UNAUTHORIZED ATTEMPTS TO OPEN, REPAIR OR MODIFY THE PRODUCT, OR ANY OTHER CAUSE BEYOND THE RANGE OF THE INTENDED USE, OR BY ACCIDENT, FIRE, LIGHTNING, POWER CUTS OR OUTAGES, OTHER HAZARDS, OR ACTS OF GOD.

LIMITATION OF LIABILITY: TO THE FULL EXTENT ALLOWED BY LAW, N-TRON ALSO EXCLUDES FOR ITSELF AND ITS SUPPLIERS ANY LIABILITY, WHETHER BASED IN CONTRACT OR TORT (INCLUDING NEGLIGENCE), FOR INCIDENTAL, CONSEQUENTIAL, INDIRECT, SPECIAL, OR PUNITIVE DAMAGES OF ANY KIND, OR FOR LOSS OF REVENUE OR PROFITS, LOSS OF BUSINESS, LOSS OF INFORMATION OR DATA, OR OTHER FINANCIAL LOSS ARISING OUT OF OR IN CONNECTION WITH THE SALE, INSTALLATION, MAINTENANCE, USE, PERFORMANCE, FAILURE, OR INTERRUPTION OF ITS PRODUCTS, EVEN IF N-TRON OR ITS AUTHORIZED RESELLER HAS BEEN ADVISED OF THE POSSIBILITY OF SUCH DAMAGES, AND LIMITS ITS LIABILITY TO REPAIR, REPLACEMENT, OR REFUND OF THE PURCHASE PRICE PAID, AT N-TRON'S OPTION. THIS DISCLAIMER OF LIABILITY FOR DAMAGES WILL NOT BE AFFECTED IF ANY REMEDY PROVIDED HEREIN SHALL FAIL OF ITS ESSENTIAL PURPOSE.

DISCLAIMER: Some countries, states, or provinces do not allow the exclusion or limitation of implied warranties or the limitation of incidental or consequential damages for certain products supplied to consumers, or the limitation of liability for personal injury, so the above limitations and exclusions may be limited in their application to you. When the implied warranties are not allowed to be excluded in their entirety, they will be limited to the duration of the applicable written warranty. This warranty gives you specific legal rights which may vary depending on local law.

GOVERNING LAW: This Limited Warranty shall be governed by the laws of the State of Delaware, U.S.A.

(Revised 2010-11-15)